

ACEKOOL

Air Purifier AD4

—
INSTRUCTION MANUAL



Thanks for your order. Please read the user manual thoroughly before using the product and keep this user manual for your future reference.

CONTENTS

■ Performance Index	01
■ Product Structure	01
■ Filtration installation	03
■ How to use	04
■ Installation instructions	05
■ Safety Information	07
■ Filter maintenance	09
■ Troubleshooting	10
■ Packing details	11

Performance Index

Transmission voltage: 24V==1.75A
Energy Efficiency Index: High efficiency leve
Noise: 53.5dB(A)

Rated Power: 11W
Particulates CADR: 120m³/h

Product Structure

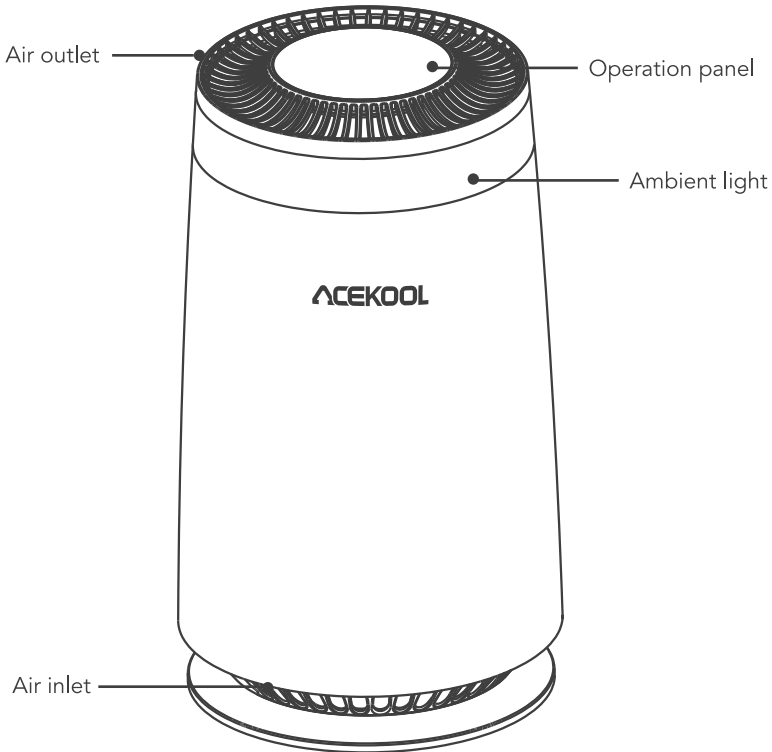

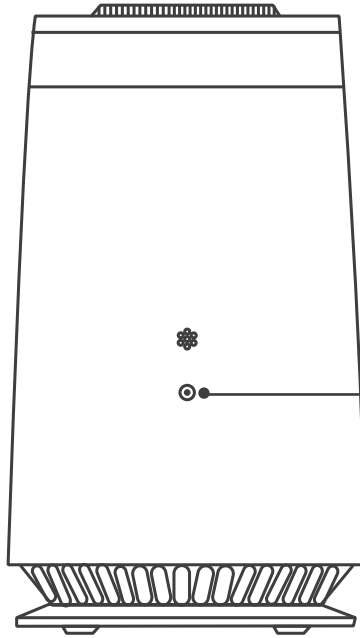

Power adapter
DC socket

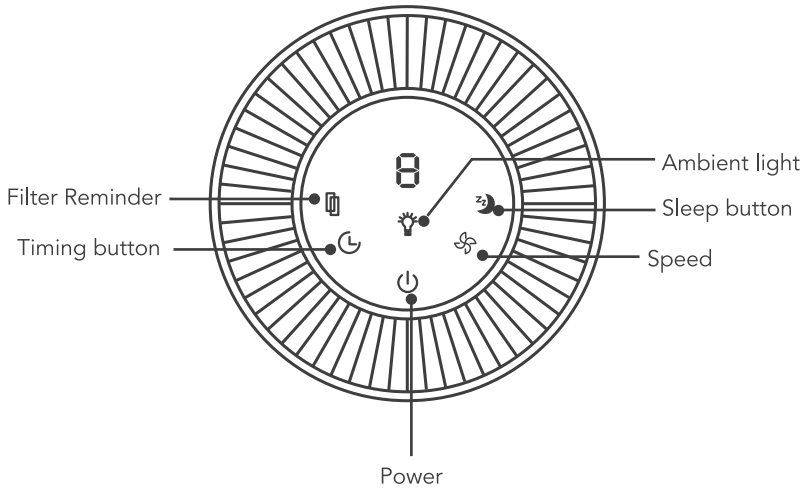

Filter Reminder
Timing button

Ambient light
Sleep button
Speed

Power

Filtration installation

- Rotate and disassemble the air inlet net (the base of the machine is facing the operator. One hand fixes the main engine, and the other hand grabs the base and rotate counter-clockwise).
- Take out the filter from the inside of the machine.
- Take out the filter from the plastic bag.
- Install the filter without the plastic bag into the machine. (Note: Filter with straps shall face toward the base).
- Assemble the air inlet net according to the reverse direction in Step 1.

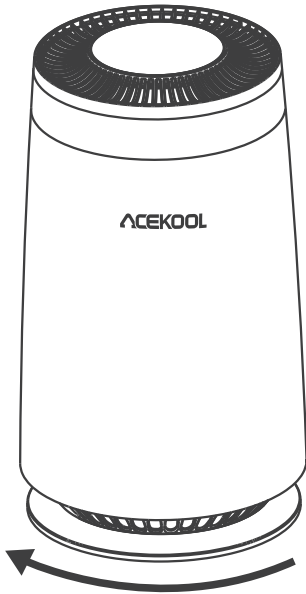

Disassemble the Filter

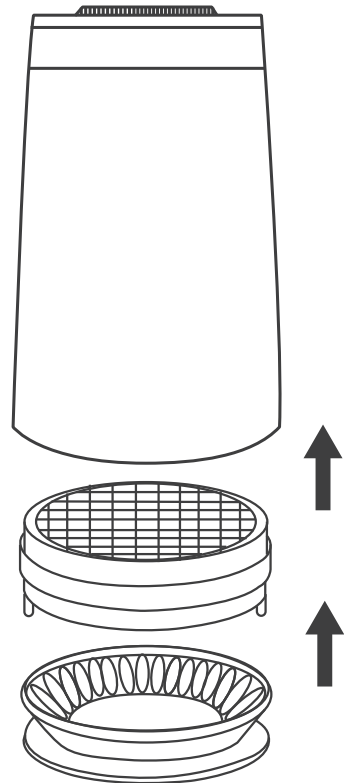

Install the Filter

Reminder:

Make sure to remove the plastic bag on the filter.

How to use

After plugging in the power, you will hear a sound "Di", the machine enters standby mode, and the air quality indicator will show red color.

Power

Power button, touch to start the machine into the default automatic operation mode. After the sensor is preheated, the air quality indication is displayed.

Sleep

Sleep button, touch the sleep button to half-light the sleep light and black out other lights, and touch the sleep button to exit the sleep mode. When the machine presses sleep mode, the ambient light enters the sleep light orange light, only during sleep. Sleep orange light can only be turned on under the sleeping mode. By default, 1 brightness can be turned on and the light can be touched lightly. Bond 1-2-3-off-1-2-3, cycle.

Timing

Timing button, touch the timing button to display a cycle of 1-8 hours on the display, and long press 2 seconds to cancel timing.

Wind speed

Wind speed button, touch the wind speed button to change the working gear of the machine in a cycle of A-1-2-3 gear (the current gear is shown when the button is pressed for the first time, and the gear is adjusted when the button is pressed again).

Ambient light

When the machine's sleep mode is pressed, the ambient light enters the sleep light (orange light), the sleep light can only be turned on in the sleep mode, the default brightness is level 1, touch the light button 1-2-3-off-1-2-3 cycles.

Installation instructions

1 Do not place in the following places:

- Direct sunlight or facing the air outlet and heated places (may cause deformation, Deterioration, discoloration, and failure).
- Equipment accessories such as TVs and radios (which may cause image distortion and noise). Please place it at a distance of 1m or more. At the same time, if the same socket is used with these devices, image plugging and noise may occur when the power plug is inserted. When this happens, plug the power cord into a different outlet.

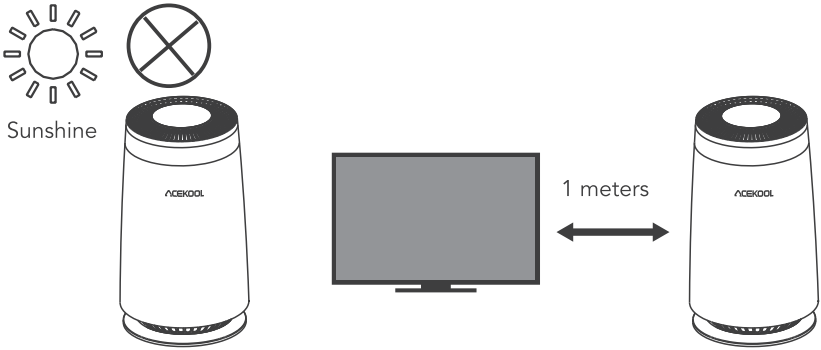

2 In order to effectively circulate the air in the room.

In order not to block the air inlet and outlet, place the product about 30cm or more from the left and right sides of the wall, furniture, curtains, etc. In order to use this product more effectively, please keep of the product at least 20cm away from the wall.

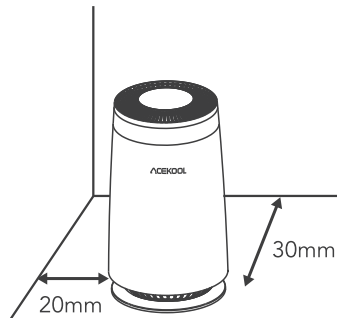

- 3** Do not place objects on the main unit (otherwise it may cause the machine to malfunction).

Special Note: Do not place magnets and metal objects.



- 4** Do not block the air inlet and outlet, for example, do not place objects on the air outlet. Or in front of the air inlet.

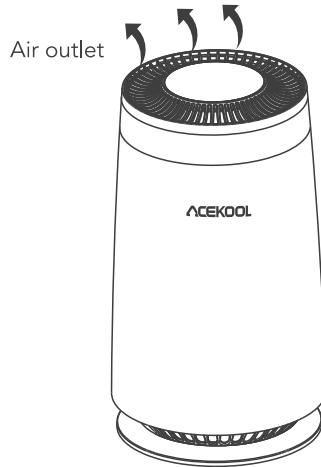
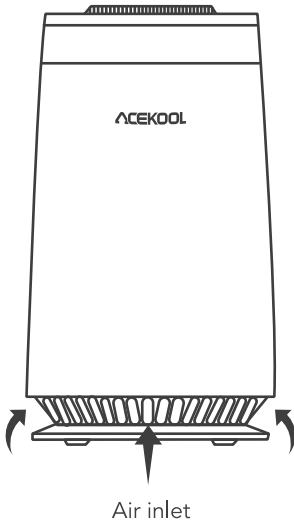

Safety Information

Prohibited

- The machine is prohibited from moving or shaking while it is running. Do not pull on the power cord while moving or storing it. Pulling the power cord may cause a short circuit or damage to the inside of the power cord, resulting in fire or electric shock.
- Do not damage the power cord or plug, and do not cut, excessively twist, pull, or twist the power cord. If the power cord is damaged, it must be replaced by the manufacturer, service department or professional to avoid danger. Non-professionals are prohibited from disassembling the machine to avoid the risk of electric shock.

- The plug and hand should not be exposed to water before plugging in the power plug, otherwise there is a danger of electric shock.
- Do not use power supplies, universal sockets or connected devices that exceed the rated value. 220V~5A AC power. Using a universal outlet that exceeds the rated value or connecting the power supply may cause the power cord to overheat and cause a fire.

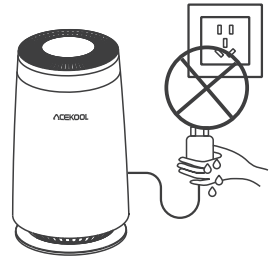

- Do not touch the power plug with wet hands, which may result in electric shock.
- Do not put your fingers or metal objects into the gap of the air outlet, otherwise it may cause electric shock or injury. Do not allow water, flammable detergents or other liquids to enter the product to avoid electric shock or fire.



- This product is not a substitute for normal ventilation equipment, daily vacuum cleaners and range hoods used in the kitchen.
- Do not use this product in gas appliances, heating devices or stove accessories.
- Do not use this product in a wet or hot environment such as a bathroom, toilet or kitchen.

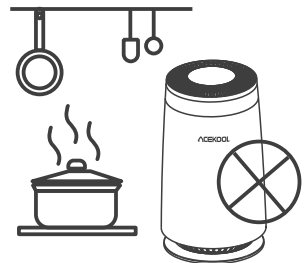

- **Never place products in such locations:**
 - 1) Unstable locations (otherwise the product may fall or fall over, resulting in injury, electric leakage, electric shock or fire.)
 - 2) Locations that are hot, humid, or wet, such as bathrooms (air purifiers may cause electric shock or fire due to electric leakage). a place where the kitchen emits soot.
- **Do not use air purifiers in indoors with incense-based insecticides.**
 - 1) Chemical residues may accumulate in the machine and then be released from the air outlet to endanger your health.
 - 2) After using the insecticide, allow the room to be thoroughly ventilated before using the air purifier.
- It is not recommended to use an air purifier when burning incense or mosquito coils, otherwise the filter of the air purifier will leave an odor.

Mandatory matters

- **Turn off the power of the machine immediately when any of the following conditions occur (may cause electric shock, sparks or smoke).**
 - 1) There is abnormal sound or vibration during operation.
 - 2) The product is abnormally hot and has a burnt odor.
- **Please clean the power plug regularly.**
 - 1) If the power plug is dusty, moisture may damage the insulated part of the plug, resulting in a fire.
 - 2) If the appliance is not used for a long time, please unplug the power cord.
- **Be sure to disconnect the power before performing maintenance on the appliance.** The product may suddenly start, causing electric shock and injury.
- **Plug the plug securely into the power outlet (if the plug is not securely inserted, it may cause electric shock due to overheating or even cause a fire).** Do not use a damaged plug or a loose power outlet.
- **Please pull the power plug from the insulated part of the hand-held plug.** Pull the power cord to pull off the power plug, which may cause damage to the power cord, electric shock, short circuit, or fire.

- When any of the following conditions occur, please turn off the power of the machine immediately and look for the maintenance department.
 - 1) The switch does not work.
 - 2) The power cord or plug is abnormally hot.
 - 3) Noticed an abnormal sound or vibration.
 - 4) There are any other abnormalities or malfunctions.
- Non-professionals are prohibited from disassembling the machine to avoid the risk of electric shock.

Precautions for safe use

Warning: To reduce the risk of electric shock, fire, or injury.

- Before use, use machine-matched power adapters or adapters that meet requirements of product nameplate specifications.
Note: Do not use damaged power adapters.
- Do not block the air inlet or outlet of the machine while in use to ensure smooth flow of air.
- Keep the machine as level as possible to prevent falling down and damage during operation.
- The desktop purifier should be used by unsupervised stressed children or people without self-care.
- Make sure to disconnect the power supply before having the electrical appliance maintained in case that the product may suddenly start, causing electric shock and injury.

Note: It is recommended to replace the filter every 2 months.

Filter maintenance

When the 1500 hour filter replacement prompt  flashes, press and hold the reset button to clear the filter indicator light and reset the timing function.

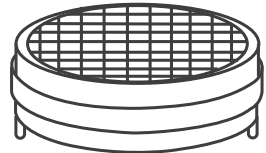

HEPA+ activated carbon composite filter (about once every two months)

- Place the filter in a ventilated place so that the harmful gases and bacteria on the surface of the filter can be volatilized. Do not expose it to excessive sunlight.
- Do not wash the filter with water.

Tips:

- Unplug the power plug before cleaning and maintenance;
- Do not operate with the filter removed (no dust removal effect, and the dust that is inhaled may cause equipment failure);
- Unplug the power cord when it is idle for a long time (it will also consume power in the standby state);
- Depending on the place of use and the method of use (for example, households with a large number of smokers or areas with severe air pollution), the filter replacement cycle may be shortened. If the filtration effect is not obvious, replace the filter in time.
- When replacing the filter, please turn off the power first.

Troubleshooting

Common fault phenomenon, fault code description and troubleshooting.

Fault phenomenon	Inspection	Solution
Can't turn on or press button no response	Is the power cord plug plugged in?	Plug in the power cord.
Button no response	<ul style="list-style-type: none"> • Is the filter dirty? • Is the filter not replaced for a long time? 	<ul style="list-style-type: none"> • Clean the filter. • Replace the filter with a new one.

Fault phenomenon	Inspection	Solution
<p>The smell of the air outlet makes people feel uncomfortable</p>	<ul style="list-style-type: none"> • Is the plastic bag on the filter screen removed by the purifier? • Is the order of the purifier filter incorrectly installed? 	<ul style="list-style-type: none"> • Remove the plastic bag from the filter before using it for the first time. • Please refer to the instructions for the installation sequence and precautions.
<p>The purifier runs for a long time but the air quality is not significantly improved</p>	<p>The filter alarm light is on: it indicates that the filter timing change timer has reached the set value.</p>	<p>At this time, after changing the filter screen, press and hold the sleep to reset.</p>

Packing details



Body

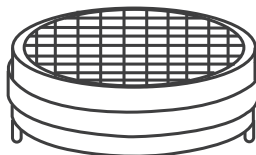

Main filter

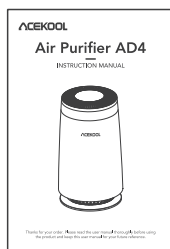

Product Manual

ACEKOOOL

— Make Life Easier —

Model: A12B

Email: support@acekool.vip

Website: <https://www.acekool.vip>

Made in China

